



LOMT-LD

# KING Drill Mini

**Indexable drill for small diameter machining  
(Ø9.0 to Ø11.5 mm)**

- Excellent centering and chip management by applying a unique insert shape
- Maintained high rigidity through variable flutes and an optimized coolant system, achieving stable chip evacuation

Indexable drill for small diameter machining ( $\varnothing 9.0$  to  $\varnothing 11.5$  mm)

# KING Drill Mini

The indexable drill offers faster setup and replacement times compared to solid drills since just the inserts need to be changed making maintenance much easier. It enables excellent productivity, economy, and flexibility across a wide range of materials and machining conditions. KORLOY has launched combining these advantages in the KING Drill Mini, a small-diameter indexable drill.

The holder features variable flutes and a coolant system optimized for small-diameter machining ( $\varnothing 9.0$  to  $\varnothing 11.5$  mm), providing excellent rigidity and stable chip evacuation. The insert improves centering performance with its V-shaped cutting edge and achieves superior chip management through curved cutting edges. Additionally, the insert design is the same for both internal and external applications, enhancing management efficiency.

**KING Drill Mini** maximizes production line efficiency in small-diameter machining by optimizing cost, time, and flexibility, making it an ideal drilling solution.

» **Maximize production efficiency**

- Quick tool changes and minimized equipment setup time

» **Excellent holder rigidity and stable chip evacuation**

- Applied optimized variable flutes and coolant system

» **Excellent centering and chip management**

- Applies a V-shaped cutting edge and a curved cutting edge

» **Improved management efficiency**

- Uses the same insert for both internal and external cutting



## Code System

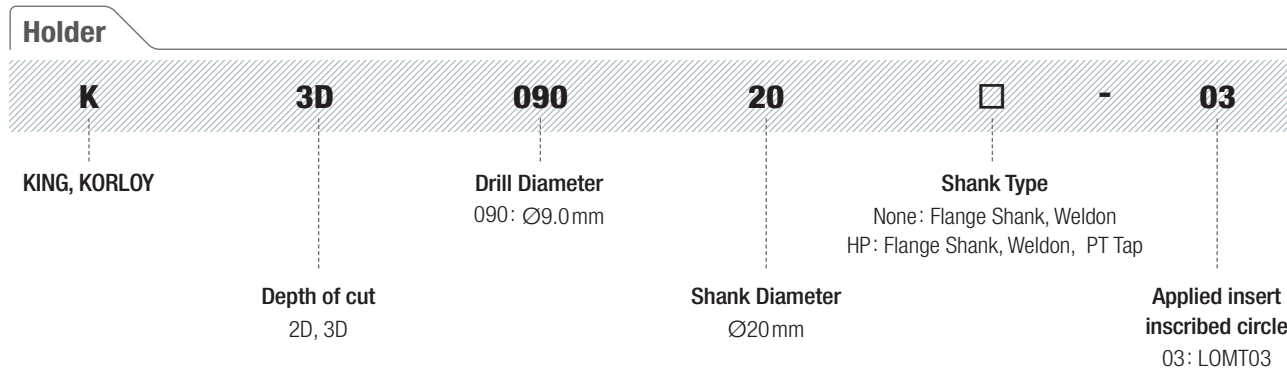

## Insert Features

- Curved cutting edge and L-type design for improved chip management
- V-shaped cutting edge applied to enhance centering

### Application of a V-shaped cutting edge

- Improves centering



### Application of L-type

- Enhances chip management

### Application of a curved cutting edge

- Improves chip management by inducing chip curvature

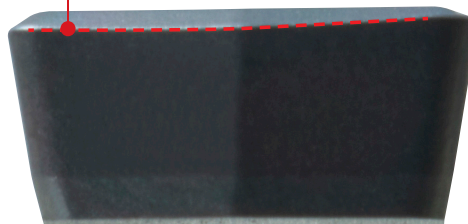

## Holder Features

- Applied variable flutes and an optimized coolant system to enhance chip evacuation
- Uses the same insert for both internal and external cutting to simplify inventory management

### Application of variable flutes

- optimized flute design to enhance holder rigidity and improve chip evacuation

### Application of an optimized coolant system

- Design tailored for small diameters to improve chip evacuation



### Using the same insert for both internal and external cutting

- Easy replacement between operations and simplifies inventory management

## Tool Selection Guide

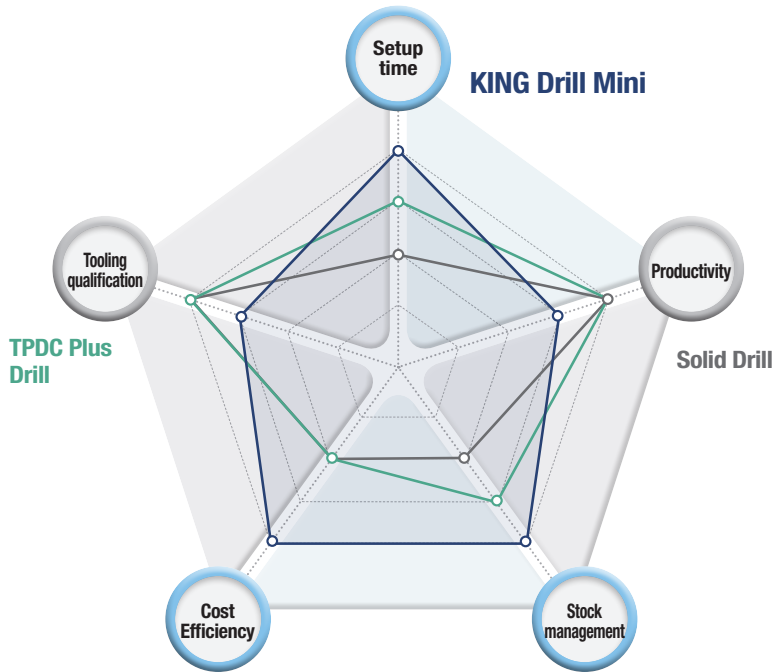

### KING Drill Mini <sup>New</sup>

- Quick tool changes
- Efficient stock management
- Reduced operating costs



### Solid Drill

- Excellent productivity
- Suitable for high-precision machining

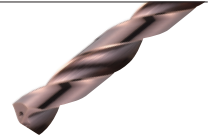

### TPDC Plus Drill

- Excellent productivity
- Suitable for high-precision machining

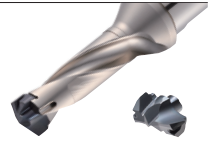

Tool	Setup time	Productivity	Stock management	Cost Efficiency	Tooling qualification
<b>KING Drill Mini</b> <sup>New</sup>	★★★★★	★★★	★★★★★	★★★★★	★★★
<b>Solid Drill</b>	★★	★★★★	★★	★★	★★★★
<b>TPDC Plus Drill</b>	★★★	★★★★	★★★	★★	★★★★

## Cost of tool demand

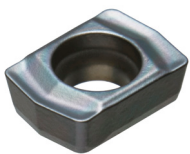

Items	Workpiece	vc (m/min)	fn (mm/rev)	ap (mm)	DC (mm)
<b>KING Drill Mini (K3D10020-03)</b>	SCM440 [HB200]	160	0.08	30(3D)	Ø10
<b>Solid Drill</b>		80	0.2	30(3D)	Ø10

### [Tool changeover time]

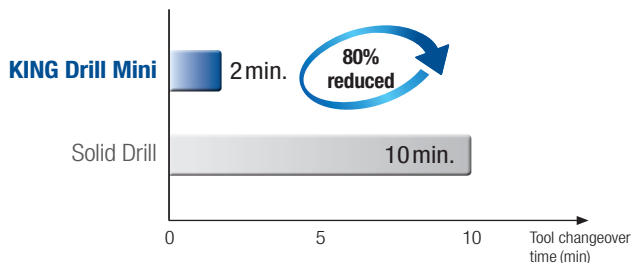

KING Drill Mini : replacing inserts inside the machine  
 Solid Drill : Machine → Remove the arbor →  
 Replace the solid tool → Measure the tool height → Mount the arbor

» 80% reduction in replacement time compared to solid drills

### [Tool cost based on 480 meters of workpiece]

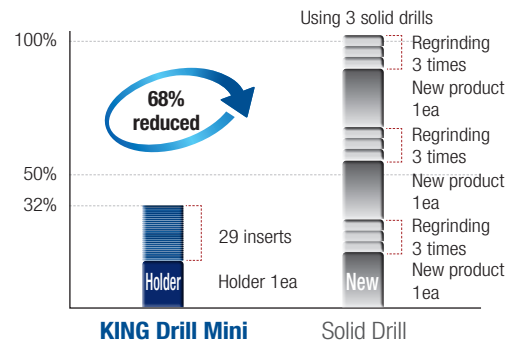

» The longer the machining length, the greater the tool cost savings effect

» With the surge in material costs, the maximized tool cost savings effect even more

## Recommended Cutting conditions

ISO	Workpiece			Non-cutting resistance (N/mm <sup>2</sup> )	Brinell hardness (HB)	Grade	vc (m/min)	Depth of cut = 2D,3D	
	Workpiece materials	KS	ISO					fn (mm/rev)	
P	Carbon steel	C=0.10 ~ 0.25%	SM15C SM25C	C15 C25	1500	80-120	PC5335	190 (130-230)	0.05-0.09
		C=0.20 ~ 0.55%	SM35C SM45C	C35 C45	1700	180-280	PC5335	150 (80-180)	0.05-0.09
	Low alloy steel ≤ 5%	Non-hardening treatment	SCM440	42CrMo4	1700	140-260	PC5300	150 (80-180)	0.05-0.09
		Hardening and tempering treatment	SCM445	-	2050	200-400	PC5300	100 (50~150)	0.05-0.09
	High alloy steel > 5%	Annealing treatment	STD11	-	1950	260-320	PC5300	100 (50~150)	0.04-0.08
		Hardened tool steel	STD61	X40CrMoV5-1	3000	300-450	PC5300	70 (30~120)	0.04-0.08
M	Austenitic	STS304 STS316	304 316	2000	135-275	PC5335	120 (60-150)	0.04-0.08	
K	Grey cast iron	GC250 GC350	250 350	900	150-230	PC5300	190 (130-230)	0.04-0.1	
	Ductile cast iron	GCD400 GCD500 GCD600	400-15 500-7 600-3	1100	150-230	PC5300	130 (100-180)	0.04-0.08	

※ The above cutting conditions are based on ideal situations, so please adjust them according to your machining environment before use.

## Precautions for insert fastening

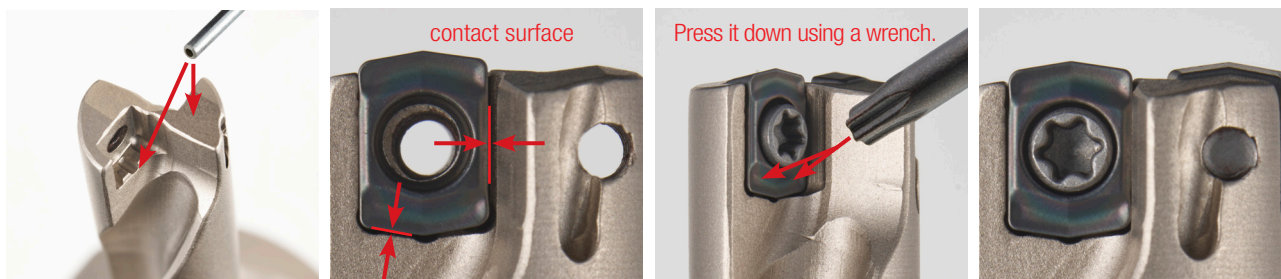

- ① As shown in Figure 1, use an air gun to remove dust from the insert contact surfaces of the holder (both internal and external edges).
- ② Place the insert into the holder, press the contact surfaces tightly as shown in Figure 2, and then fasten the screw.
- ③ When fastening, make sure the insert is fully seated against the holder's bottom contact surface. Using a wrench, gently press the top of the insert avoiding the cutting edge while tightening.
- ④ After fully tightening the screw, perform a comprehensive final visual inspection to check for any lifting or proper seating of the insert.

\* If the insert and tip seat are not fully seated during fastening, the insert may loosen, which can lead to a drop in performance.

- ※ Please replace the screw when it shows signs of wear.
- ※ Use the included wrench to fasten the screw securely.

## Performance evaluation

### Hole tolerance

<b>Workpiece</b>	SCM440, 200(L) × 300(W) × 300(H), Square bar	
<b>Cutting condition</b>	vc(m/min) = 180, fn(mm/rev) = 0.08, ap(mm) = 30, Wet	
<b>Tool</b>	<b>Insert</b> LOMT030104-LD(PC5300)	<b>Holder</b> K3D10020-03

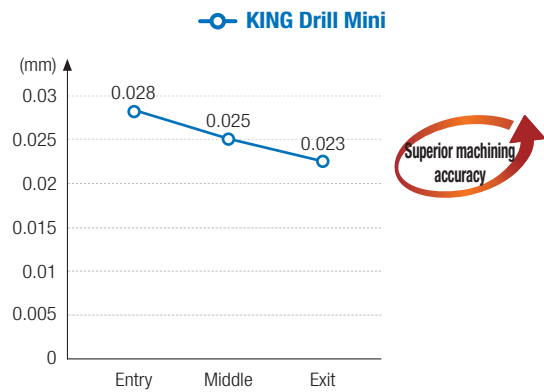
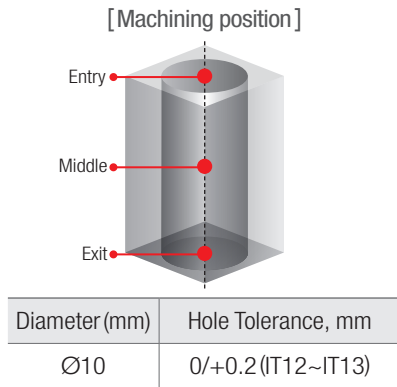

### Excellent surface finish

<b>Workpiece</b>	200(L) × 300(W) × 300(H), Square bar	
<b>Cutting condition</b>	vc(m/min) = 80~140, fn(mm/rev) = 0.06~0.1, ap(mm) = 30, Wet	
<b>Tool</b>	<b>Insert</b> LOMT030104-LD	<b>Holder</b> K3D09020-03

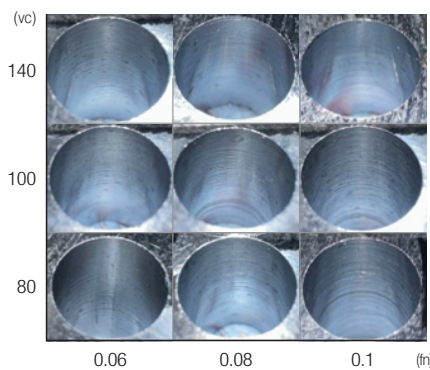

[ SCM440(HB200)-PC5300 ]

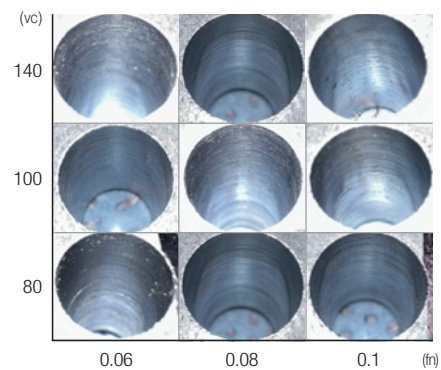

[ SM45C(HB190)-PC5335 ]

### Excellent chip control

<b>Workpiece</b>	200(L) × 300(W) × 300(H), Square bar	
<b>Cutting condition</b>	vc(m/min) = 60~140, fn(mm/rev) = 0.04~0.1, ap(mm) = 30, Wet	
<b>Tool</b>	<b>Insert</b> LOMT030104-LD	<b>Holder</b> K3D11520-03

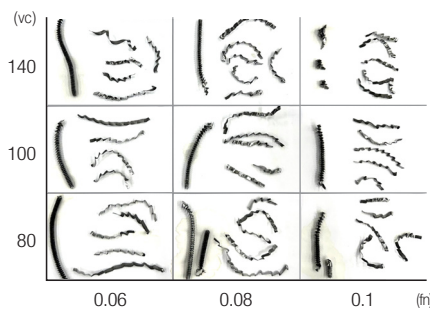

[ SCM440(HB200)-PC5300 ]

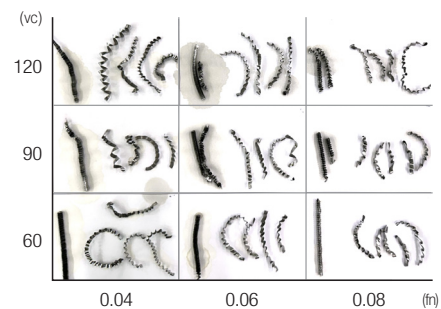

[ STS304(HB200)-PC5335 ]

» Consistent chip formation

## KING Drill Mini – Tap For pre-drilling holes for tapping

- The KING Drill Mini is designed for pre-tapping hole machining. It supports tap specifications divided into Metric and Inch types, and can be used for both through holes and blind holes.

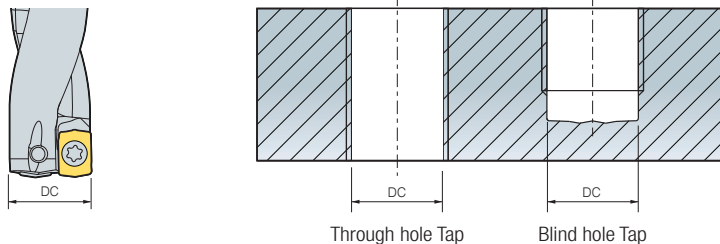

(mm)

Type	Tap	DC	Designation
Metric	M10 x 1	9	K3D09020-03
	M10 x 0.75	9.3	K3D09320-03
	M11 x 1.5	9.5	K3D09520-03
	M11 x 1	10	K3D10020-03
	M12 x 1.75	10.3	K3D10320-03
	M12 x 1.5	10.5	K3D10520-03
	M12 x 1.25	10.8	K3D10820-03
	M12 x 1	11	K3D11020-03
	M13 x 1.5	11.5	K3D11520-03
Inch	7/16-14 UNC	9.3	K3D09320-03
	1/2-13 UNC	10.8	K3D10820-03
	1/2-20 UNF	11.5	K3D11520-03

## Drill and hole tolerance

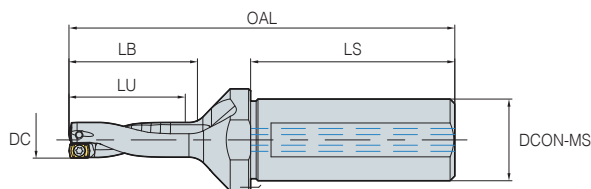

(mm)

Type	KING Drill Mini	KING Drill
2D, 3D	Diameter	Ø9 ~ Ø11.5
	Drill tolerance	-0.03 ~ 0.07
	Hole Tolerance	-0.1 ~ 0.2

# Special drill order form

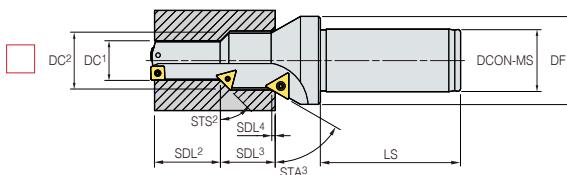
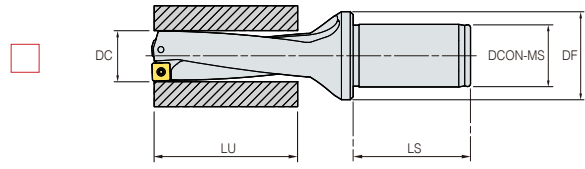
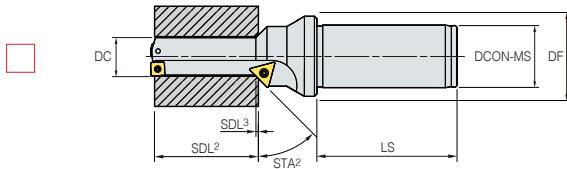
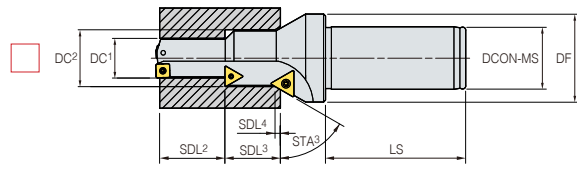
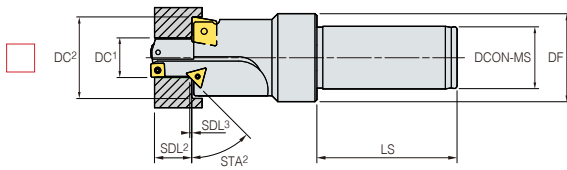

**Coolant type**

Internal Coolant Plug Type  
  Internal Coolant Type without Plug  
  External Coolant Type

**tooling type**

Blind hole  
  Through hole

**Shank type**

Flat Type  
  Weldon Type  
  Whistle Notch Type

**Side lock position**

Parallel to the external edge (standard type)  
  90 degrees to the external edge (standard type)

Standard type with 180° direction relative to the external edge  
  270 degrees to the external edge (standard type)

**Special Notes**

- Current tool in use :
- Current operating/machining conditions :
  - RPM or cutting speed, vc in m/min :
  - Feed rate per minute mm/min or feed per revolution mm/rev :
  - Depth of cut :
- Criteria for tool life judgment :
- Equipment in use
  - Machining center :
  - General-purpose lathe :
  - CNC lathe :

 **Insert**

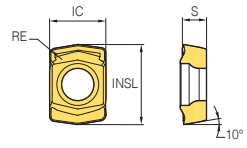

Picture	Designation	Coated		Dimension (mm)				Geometry
		PC5335	PC5300	IC	RE	S	D1	
	LOMT030104-LD	●	●	3.5	0.4	1.5	5	

●: Stock item

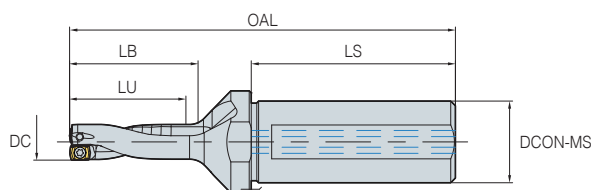
## KING Drill Mini (2D, 3D)



(mm)

Designation	Stock	DC	DCON-MS	LU	LB	LS	OAL	Available inserts	Screw 	Wrench 	Tightening torque
<b>K2D</b> 09020-03		9	20	18	24	50	87	LOMT030104-LD	FTKA01835	TW06P	0.4 [N·m]
09320-03		9.3	20	18	24	50	87				
09520-03		9.5	20	18	24	50	87				
10020-03		10	20	20	26	50	89				
10320-03		10.3	20	20	26	50	89				
10520-03		10.5	20	21	27	50	90				
10820-03		10.8	20	21	27	50	90				
11020-03		11	20	22	29	50	92				
11520-03		11.5	20	22	29	50	92				
<b>K3D</b> 09020-03	●	9	20	27	33	50	96				
09320-03	●	9.3	20	27	33	50	96				
09520-03	●	9.5	20	27	33	50	96				
10020-03	●	10	20	30	36	50	99				
10320-03	●	10.3	20	30	36	50	99				
10520-03	●	10.5	20	31	38	50	101				
10820-03	●	10.8	20	31	38	50	101				
11020-03	●	11	20	33	41	50	104				
11520-03	●	11.5	20	33	41	50	104				

●: Stock item

## ⚠ For the safe metalcutting

- Use safety supplies such as protective gloves to prevent possible injury while touching the edge of tools.
- Use safety glasses or safety cover to hedge possible dangers. Inappropriate usage or excessive cutting condition may lead tool's breakage or even the fragment's scattering.
- Clamp the workpiece tightly enough to prevent its movement while its machining.
- Properly manage the tool change phase because the inordinately used tool can be easily broken under the excessive cutting load or severe wear, and it may threat the operator's safety.
- Use safety cover because chips evacuated during cutting are hot and sharp and may cause burns and cuts. To remove chips safely, stop machining, put on protective gloves, and use a hook or other tools.
- Prepare for fire prevention measures as the use of the non-water soluble cutting oil may cause fire.
- Use safety cover and other safety supplies because the spare parts or the tools can be pulled out due to centrifugal force while high speed machining.



**Head Office:** Holystar B/D, 326, Seocho-daero, Seocho-gu, Seoul, 06633, Republic of Korea  
Tel: +82-2-522-3181 Fax: +82-2-522-3184, +82-2-3474-4744 Web: www.korloy.com E-mail: sales.khq@korloy.com

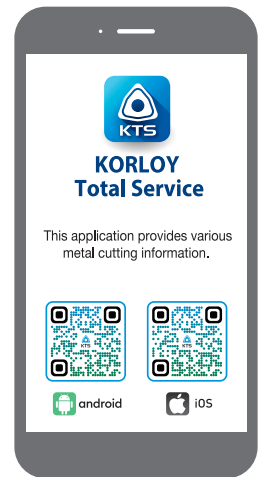

### **KORLOY AMERICA**

620 Maple Avenue, Torrance, CA 90503, USA  
Tel : +1-310-782-3800 / +1-888-711-0001 Fax : +1-310-782-3885  
E-mail : sales.kai@korloy.com

### **KORLOY INDIA**

Plot No. 415, Sector 8, IMT Manesar, Gurgaon 122051, Haryana, India  
Tel : +91-124-4391790 Fax : +91-124-4050032  
E-mail : sales.kip@korloy.com

### **KORLOY TURKIYE**

Ziya Gokalp, Mah. Seyit Onbasi Cad. No:36, 3 Kat,  
iC Kapi No : 5 Basaksehir/Istanbul, Turkiye  
Tel : +90-212-813-8874 E-mail : sales.ktl@korloy.com

### **KORLOY RUSSIA**

115280, Moscow, vn.ter.g. municipal district Danilovsky,  
street Masterkova, house 4, premises 1/2  
Tel : +7-495-280-1458 Fax : +7-495-280-1459 E-mail : sales.krc@korloy.com

### **KORLOY UK**

13 Approach Rd, Raynes Park, London SW20 8BA, United Kingdom  
E-mail : sales.kul@korloy.com

### **KORLOY EUROPE**

Gablonzer Str. 25-27, 61440 Oberursel, Germany  
Tel : +49-6171-27783-0 Fax : +49-6171-27783-59  
E-mail : sales.keg@korloy.com

### **KORLOY BRASIL**

Av. Aruana 280, conj.12, WLC, Alphaville, Barueri, CEP06460-010, SP, Brasil  
Tel : +55-11-4193-3810 Fax : +55-11-4193-5837  
E-mail : sales.kbl@korloy.com

### **KORLOY CHILE**

Av. Providencia 1650, Office 1009, 7500027  
Providencia-Santiago, Chile  
Tel : +56-229-295-490 E-mail : sales.kcs@korloy.com

### **KORLOY MEXICO**

Avenida de las Ciencias, No. 3015, Interior 406, Juriquilla Santa Fe,  
C.P.76230 Querétaro, Mexico  
Tel : +52-442-193-3600 E-mail : sales.kml@korloy.com

### **KORLOY FACTORY INDIA**

Plot NO. 415, Sector 8, IMT Manesar, Gurgaon 122051, Haryana, India  
Tel : +91-124-4391790 Fax : +91-124-4050032  
E-mail : pro.kim@korloy.com

